

A Cooperative Diversity-based Robust MAC Protocol in Wireless Ad Hoc Networks

Sangman Moh, *Member, IEEE*, and Chansu Yu, *Senior Member, IEEE*

Abstract—In interference-rich and noisy environment, wireless communication is often hampered by unreliable communication links. Recently, there has been active research on cooperative communication that improves the communication reliability by having a collection of radio terminals transmit signals in a cooperative way. This paper proposes a medium access control (MAC) algorithm, called Cooperative Diversity MAC (CD-MAC), which exploits the cooperative communication capability of the physical (PHY) layer to improve robustness in wireless ad hoc networks. In CD-MAC, each terminal proactively selects a partner for cooperation and lets it transmit simultaneously so that this mitigates interference from nearby terminals and thus improves the network performance. For practicability, CD-MAC is designed based on the widely adopted IEEE 802.11 MAC. For accurate evaluation, this study presents and uses a realistic reception model by taking bit error rate (BER), derived from Intersil HFA3861B radio hardware, and the corresponding frame error rate (FER) into consideration. System-level simulation study shows that CD-MAC significantly outperforms the original IEEE 802.11 MAC in terms of packet delivery ratio and end-to-end delay.

Index Terms—Wireless ad hoc network, cooperative diversity, cooperative transmission, partner selection, MAC.

I. INTRODUCTION

In wireless ad hoc networks, signal fading (due to communication environment) and interference (due to other nodes) are two major obstacles in realizing their full potential in delivering signals. Cooperation among the nodes is considered critically important in addressing these problems. Conventional routing layer solutions support the cooperative delivery of information by selecting intermediate forwarding nodes for a given source-destination pair. However, it may be difficult to maximize the performance unless nodes are coordinated to cooperate at lower levels. This is because the network capacity is often determined by the underlying MAC and PHY layer protocols. For example, consider a carrier sense (CS)-based medium access control (MAC) protocol such as *Distributed Coordination Function* (DCF) in IEEE 802.11 standard. A node is regarded as a greedy adversary to other nodes in its proximity as they compete with each other to grab the shared medium, interfere each other's communication, and cause collisions. At the physical layer, a node's data transfer not only provides interference to other nodes depriving their opportunity of using the medium but also incurs energy wastage by rendering them to overhear.

A subset of this paper was presented at IEEE ICC'07 [1].

Sangman Moh is an assistant professor in School of Computer Engineering, Chosun University, 375 Seoek-dong, Dong-gu, Gwangju, Korea, Email: smmoh@chosun.ac.kr

Chansu Yu is an associate professor in Dept. of Electrical and Computer Engineering, Cleveland State University, 2121 Euclid Avenue, Cleveland, OH 44115. Email: c.yu91@csuohio.edu

Recently, there has been active research in developing cooperative MAC algorithms such as path-centric medium access [2] and MAC-layer packet relaying [3], [40], [41]. For example, in *Coop-MAC* [40] and *rDCF* [41], cooperating relay nodes are determined in a proactive manner and are used to forward frames at higher bit rates. Their objective is to deliver frames faster by using multi-rate capability, which does not necessarily enhance the communication reliability in interference-rich environment. On the other hand, *cooperative communication* at the PHY layer attracts a lot of researchers' attention [4]–[6] because it directly enhances the link reliability. It refers to scenarios in which distributed radios interact with each other to jointly transmit information in wireless environments [6]. In other words, cooperative communication exploits diversity offered by multiple users, known as *multiuser* or *cooperative diversity*. It dramatically improves *bit error rate* (BER), resulting in a more reliable transmission and a higher throughput. It is important to note that the primary motivation of cooperative diversity in this paper is to improve the link reliability over wireless fading channels while that in previous studies [5], [6] is to lengthen the transmission range.

Earlier, we presented a MAC layer protocol, called *cooperative diversity MAC* (CD-MAC), that exploits the above-mentioned cooperative communication capability at the PHY layer in wireless ad hoc networks [1]. Unlike many previous studies, the proposed CD-MAC operates on a single channel and uses a single partner (relay). It assumes that radio hardware supports *cooperative space-time coding* [7], [8]. Each transmitter sends its signal together with its partner in a cooperative manner to improve the communication reliability. A key element of the CD-MAC is the selection of *partner*; each node monitors its neighbors and dynamically determines a single partner as the one that exhibits the best link quality.

This paper enhances the CD-MAC algorithm presented in our earlier work [1] in the following two ways. (i) In the original CD-MAC algorithm, a sender and its partner cooperatively transmit a frame whenever the sender experiences a transmission failure. However, a transmission failure due to collisions/interference should be treated differently from that due to channel error [13]. If it is due to the latter, it helps because the communication becomes more robust in the presence of channel error. This is incorporated in the enhanced CD-MAC protocol presented in this paper. (ii) The original CD-MAC assumes to exchange two short control frames (RTS and CTS) before transmitting a data frame, which is not usually the case in practice. In this paper, the two control frames are not mandatory but optionally employed to increase performance.

The proposed CD-MAC algorithm has been evaluated via simulation using ns-2 [23]. While most of previous studies concentrated on evaluating BER and outage probability via cooperative diversity, this paper evaluates system-level performance such as packet delivery capability. For more accurate evaluation,

we use BER and *frame error rate* (FER) statistics derived from the product specification of Intersil HFA3861B radio hardware [12] rather than the deterministic reception model used in most of simulation and analysis studies. To the best of the authors' knowledge, this is the first study on cooperative communication that offers detailed system-level comparisons with the BER and FER considered. This paper significantly expanded the evaluation and performance comparison than the earlier work [1]. End-to-end packet delay is evaluated and compared between CD-MAC and DCF. Performance variation due to the changes in environment noise level has been observed to see if CD-MAC performs better than DCF consistently regardless of the noise level. Effect of network traffic in terms of varying number of communication sessions as well as varying packet rate has been measured to understand the scalability of CD-MAC.

The rest of the paper is organized as follows: Background and system model are summarized in the following section. Section III presents the proposed CD-MAC protocol; the four-way handshaking algorithm and the partner selection mechanism are described. Performance study including reception model, simulation environment, and evaluation results is discussed in Section IV. Finally, conclusions are given in Section V.

II. BACKGROUND AND SYSTEM MODEL

CD-MAC is an efficient MAC scheme that makes use of PHY layer cooperation for reliable communication. Before explaining the CD-MAC protocol in Section III, this section describes the system model assumed throughout this paper. Section II-A explains the cooperation model at the PHY discussed in the literature. Related work on cooperative diversity in wireless ad hoc networks is found in Section II-B. Section II-C explains signal propagation and reception model. Section II-D discusses DCF, which is the underlying MAC protocol assumed in this paper.

A. Cooperative Diversity

Diversity techniques such as co-located antenna array can mitigate the interference problem by transmitting redundant signals over essentially independent channels. However, due to the physical size and hardware complexity, it may not be always feasible in practice for each node to have multiple antennas. Recently, a new class of diversity techniques called *cooperative diversity* has been proposed, in which distributed radios interact with each other to jointly transmit information exploiting diversity offered by multiple users [4]–[6], [35].

There are two types of cooperative diversity algorithms: *repetition-based* and *space-time-coded* [7]. The former consists of the sender broadcasting its transmission both to its receiver and potential partners (or relays) and the partners repeating the sender's message individually on orthogonal channels (frequency or time). Several repetition-based cooperation methods have been studied. Among them, *amplify-and-forward* and *decode-and-forward* method are two well-known techniques [5], [6]. Partners (relays) amplify or fully decode their received signals and repeat information to the intended receiver; hence, they are called *repetition-based cooperative algorithms*. The corresponding benefits come at a price of decreasing bandwidth efficiency (increasing time delay) because each partner requires its own channel (time) for repetition [7].

The latter operates in a similar fashion except that all the partners transmit simultaneously on the same channel using a

suitable coding scheme. For realizing cooperative diversity while allowing partners to transmit on the same channel, (*orthogonal distributed space-time coding* (DSTC) [7], [8] can be used. Historically, *space-time coding* (STC) and *space-time block coding* (STBC) were initially developed to offer transmit diversity in multi-antenna systems [14], [15]. In other words, multiple copies of a data stream are encoded based on the space-time code and transmitted through multiple antennas simultaneously. STBC has been dominant for both *multiple-input-single-output* (MISO) and *multiple-input-multiple-output* (MIMO) system architectures because the maximum likelihood decoding can be accomplished with only linear processing at the receiver while achieving the full diversity. It is now a part of W-CDMA and CDMA-2000 standards [14].

DSTC is a distributed multi-user version of STBC. In other words, transmission of multiple copies of a data stream is distributed among the cooperating nodes. Consider a simple three-node example with a sender, a partner (relay) and a receiver device as in Fig. 1. In time slot 1, the sender device transmits two symbol blocks, $s(n)$ and $s(n+1)$, to the partner. The sender and its partner cooperatively transmit the two blocks in time slot 2 as in the figure. Here, those two symbol blocks are encoded using the given space-time coding matrix F and G . By virtue of the orthogonality of the two matrices, it is not only possible for both the sender and the partner to transmit simultaneously on the same channel but also improves the reliability of the communication. An interested reader should refer to [8] for more details.

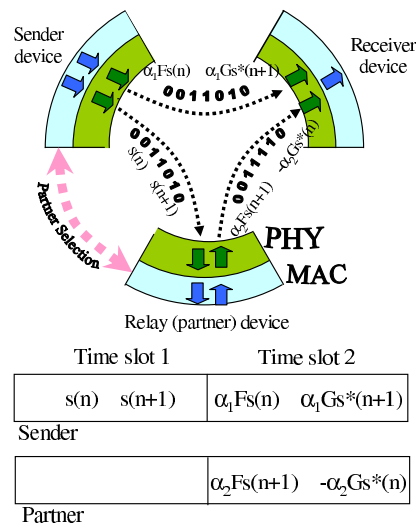

Fig. 1. Cooperative communication using distributed space-time coding scheme based on single channel model. (* denotes conjugation and two real coefficients α_1 and α_2 are related to each other by $\alpha_1^2 + \alpha_2^2 = 1$ [8].)

B. Cooperative Diversity in Wireless Ad hoc Networks

Reliability of a communication link is very important in wireless ad hoc networks, because they are often deployed as a temporary network in noisy and unstable environments. A number of recent studies consistently noted the benefit of cooperative transmission in wireless ad hoc networks [16]–[18]. Studies reported in [9]–[11] discuss the MAC layer support that is necessary to exploit the cooperative diversity. Kojima *et al.* studied *distributed automatic repeat request* mechanism, where a source

and distributed repeater nodes (relays) simultaneously transmit the same data frame repeatedly until the source correctly receives an acknowledgement from the destination [9]. Each node contributes to obtain the diversity gain by encoding the repeated data based on DSTC. This mechanism improves the communication reliability at the cost of more power dissipation, more routing overhead, and more network traffic, and consequently results in the reduction of network throughput.

Azgin *et al.* proposed *Cooperative MAC* (C-MAC) and the corresponding routing protocols for wireless ad hoc networks [10]. In C-MAC, four control frames such as *relaying start* (RS), *relay acknowledgement* (RA), *relay broadcasting* (RB) and *transmission start* (TS) are defined in addition to conventional *request-to-send* (RTS), *clear-to-send* (CTS), and ACK. While DATA frame is transmitted using cooperative diversity, all control frames (RTS, CTS, RS, RA, RB, TS, and ACK) are transmitted through the conventional *single-input-single-output* (SISO) link. This results in unreliable delivery of control frames, which may limit the applicability of this protocol. In addition, directional knowledge of neighbors is required for routing.

Jakllari *et al.* introduced a MAC protocol that supports the virtual MISO and multiple partners [11]. In this approach, a SISO path between a source and a destination is discovered using an existing routing protocol such as *Ad-hoc On-demand Distance Vector* (AODV) [19] or *Dynamic Source Routing* (DSR) [20] and multiple partners are selected by exchanging periodic one-hop hello packets. The source and its partners cooperatively transmit to an intermediate node which is several-hop away on the routing path. This algorithm exploits the cooperative diversity to lengthen the transmission range. A shortcoming is that, for successful cooperation, the receiver must have at least k partners when the sender uses k partners. For a transmission, as many partners as possible should be chosen and they transmit pilot tones in orthogonal channels to estimate the channel state.

The aforementioned schemes are different from the proposed CD-MAC in that they define new frame types, require changes in frame formats, need positional information of the receiver, use multiple channels, and/or require modifications in routing layer protocols [10], [11]. CD-MAC operates on a single channel and is consistent with the underlying DCF and standard routing layer protocols.

C. Signal Propagation and Reception Model

Radio propagation within a mobile channel is described by means of three effects: *attenuation* due to distance between the sender and the receiver, *shadowing* due to the lack of visibility between the two nodes, and *fading* due to multipath propagation [21]. To successfully receive a transmission, the following two conditions have to be satisfied. First, the receiver must be within the transmission range of the sender. In other words, the received signal power must be equal or larger than the *receive threshold*. Second, the received signal power must be strong enough to overcome the influence of the noise and interference. This condition is described by the following *signal-interference-noise ratio* (SINR) model.

$$SINR = \frac{P_r}{N + \sum_{i \neq r} P_i} \geq Z_0$$

where P_r is the received signal power, P_i denotes the received power of other signals arrived at the receiver, N is the effective

noise at the receiver, and Z_0 is the minimum required SINR, commonly called *capture threshold*.

In the aforementioned reception model, N and Z_0 are two important parameters that affect the communication reliability. First, noise can be generated by the receiver itself as well as by environment. The effective noise level from the receiver can be obtained by adding up the noise figure of a network interface card (NIC) onto the thermal noise [22]. Second, the capture threshold Z_0 is not a constant in practice although a fixed value of 10 dB has been widely used in numerous analysis and simulation-based studies (*e.g.* 10dB is a default value in ns-2 network simulator [23]). In other words, signal reception in real-life environment is not deterministic. A smaller SINR increases *bit error rate* (BER) and thus a communication could fail with a higher probability. We adopt this model in this paper and the success or failure of a communication is determined probabilistically based on SINR, which will be discussed in more detail in Section IV-A.

D. DCF (IEEE 802.11 MAC)

According to the SINR model mentioned in the previous subsection, interference from other signals is also an important factor. In general, the performance of a MAC protocol is greatly affected by collisions or interference because a frame transmission to a busy receiver is not queued but incurs transmission failures for both frames. For example, a simple algorithm such as ALOHA allows many data transfers to occur simultaneously but its throughput is critically limited because of the lack of collision avoidance mechanism. On the other hand, *carrier sense* (CS)-based MAC algorithms such as DCF alleviate the interference problem by mandating a node to hold up pending transmission requests when it observes a carrier signal above a certain value, called *CS threshold* [24]. A lower CS threshold will result in less interference by rendering nodes in a wider range to defer. This could improve the network performance by minimizing the interference problem but at the same time it could affect negatively by allowing fewer concurrent data transfers in the network [3], [25].

The DCF optionally employs two short control frames, *Request-to-Send* (RTS) and *Clear-to-Send* (CTS), to further reduce collisions. In other words, a sender transmits an RTS, a receiver replies with an CTS, the sender transmits a data frame, and then the receiver replies with an ACK (acknowledgement) to complete the communication session. This is known as *four-way handshaking*. During the process, every neighboring node of the two communicating nodes recognizes their communication by overhearing the control frames and refrains from initiating its own transmission. However, the RTS/CTS exchange does not offer benefits in practice as observed in [26], [27]. This is partly because 802.11 devices usually employ a low CS threshold, which keeps neighboring nodes to defer anyway.

On the other hand, the RTS/CTS exchange has been used for other purposes (*i.e.*, for reserving a time interval) in some derivatives of IEEE 802.11 such as IEEE 802.11e and IEEE 802.11g. In a recent study, Kim *et al.* suggested to use it to differentiate transmission failure due to collision/interference from that due to channel error [13]. The transmission failure of an RTS is considered due to collisions or interference because RTS frame is very short (particularly when it is transmitted at the lowest data rate). The transmission failure of a data after a successful RTS/CTS exchange is considered due to channel error

because collisions are already excluded based on the RTS/CTS mechanism. This paper incorporates this method in the proposed CD-MAC to help a node to make a decision whether to cooperate or not, which will be detailed in the next section.

III. COOPERATIVE DIVERSITY MAC

In a wireless ad hoc network, many nodes are spread over a network area and communicate with each other using multihop routed rather than direct communication. A link breakage at one hop of a multihop route, caused by either the fluctuating communication environment, interference or node mobility, would bring a lot of overhead: (i) The intermediate node experiencing the link breakage needs to report this event (route unavailability) to the original source of the data packets, (ii) a new alternative route must be discovered, and (iii) data transmission up to that intermediate node becomes useless. This is not avoidable if the cause of the problem is node mobility. However, if it is due to the fluctuating communication environment or channel error, it would be much better that the intermediate node tries again with the help from its neighbors or partners.

This section proposes a new MAC protocol called *cooperative diversity MAC* (CD-MAC) for single-channel wireless ad hoc networks. It exploits cooperative diversity via DSTC discussed in Section II-A to overcome the link breakage problem due to unreliable, fluctuating communication environment. In CD-MAC, each node proactively selects one partner device for its cooperative communication. Two-node cooperation is advantageous compared to multi-node cooperation because orthogonal code design is not possible with more than two cooperating nodes without decreasing the data rate [28], [29]. Moreover, the two-node cooperation is easier to coordinate than multi-node cooperation and the partner selection is simpler. Sections III-A and III-B explain the 4-way handshaking of a simple cooperation scheme and the proposed CD-MAC protocol, respectively. They are followed by the discussion on partner selection in Section III-C.

A. A Simple Cooperation Scheme

The proposed CD-MAC is based on DCF of IEEE 802.11 standard. If a primary link imposed by the upper layer routing protocol is reliable enough to successfully transmit frames, the conventional MAC (*i.e.*, DCF) is used and no cooperative transmission is enabled. If it fails, however, the sender retransmits the frame but cooperatively with its partner. Fig. 2 shows the cooperative transmission of a data stream along a routing path between a source (s) and a destination (d). Each intermediate node including s and d is paired with its partner, both of which preferably share the same communication environment. For example, node i transmits its frame to the next hop node j over the primary link. If it fails, node i and its partner r_i retransmit the frame cooperatively. (Node i is supposed to retransmit the frame “alone” in DCF.) Note that, during the retransmission, the partner r_i overhears the frame (in blocks) from the sender i in time slot 1, encodes it using DSTC, and cooperatively transmits it in time slot 2 as discussed in Section II-A. Likewise, the node j transmits its frame (*e.g.*, ACK) to node i cooperatively with its partner r_j .

A fundamental question in cooperative communication is to determine when to cooperate. In a simple cooperation scheme, this

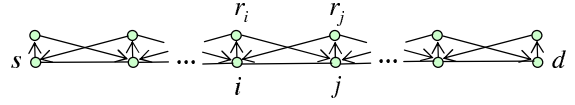

Fig. 2. Cooperative transmission with partners along a routing path.

decision can be made based on the RTS/CTS control frame. That is, if node i receives a CTS frame successfully from receiver j after transmitting an RTS frame, it transmits a data frame without cooperation according to the DCF principle. However, if i does not receive a CTS from j (either i 's RTS fails to reach j or j 's CTS fails to reach i), then the cooperative transmission with its partner, r_i , is attempted as shown in Fig. 3(a). That is, i and r_i cooperatively transmit *cooperative RTS* (C-RTS) and j and r_j cooperatively transmit *cooperative CTS* (C-CTS). After receiving C-CTS, i and r_i cooperatively transmit data frame to j (and r_j). After receiving the data frame, j and r_j cooperatively transmit *cooperative ACK* (C-ACK) to node i .

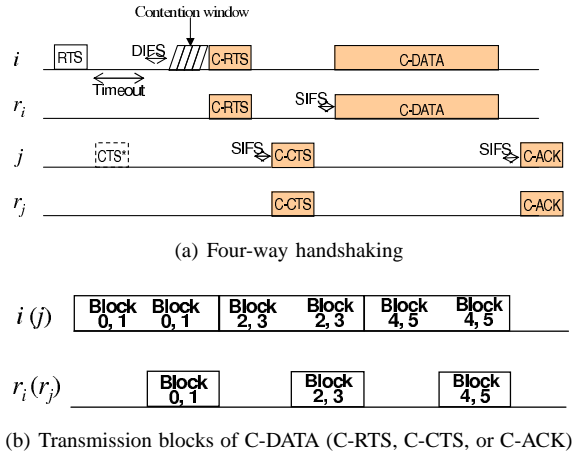

Fig. 3. A simple cooperation scheme with partners r_i and r_j on a weak link (i, j). (SIFS or *short interframe space* and DIFS or *DCF interframe space* are the spaces between frames in the four-way handshaking procedure. The DATA frame in this figure consists of 6 blocks.)

However, the simple cooperation scheme has a number of problems: First, each cooperative transmission follows the same transmission principle as drawn in Fig. 1 and redrawn in Fig. 3(b); namely, two symbol blocks from the sender to the partner in time slot 1 and then from both the sender and the partner to the receiver in time slot 2 (i/r_i to j for C-RTS and C-DATA, and j/r_j to i for C-CTS and C-ACK). This means that the transmission time becomes twice longer than that without cooperation because we assume to use off-the-shelf radios with half-duplex antenna that operates on a single channel. Correspondingly, the Duration/Connection (DI) field in C-RTS, C-CTS, C-DATA and C-ACK frame must be set properly. The DI field defines the time period needed to finish the whole communication session including the final ACK frame. Neighboring nodes set their *network allocation vector* (NAV) according to the value in the DI field and defers their transmission while it is nonzero, thus avoiding collisions. This is called *virtual carrier sense*. In the simple cooperation scheme, the sender needs to take the extended transmission time into consideration when calculating the DI for the frame transmitted in a cooperative way.

Second, an RTS failure can be due to collisions/interference from other nodes' communications as explained in Section II-D. If the sender (i) retransmits the same frame at a later time, it could be successful with a high probability even without cooperation. Therefore, the initiation of cooperative communication upon an RTS failure may not be desirable.

Third, the RTS/CTS exchange is rarely used in practice. Since the carrier sensing is performed in a conservative manner in practical systems, it effectively eliminates the problem associated with "the hidden terminals" as discussed in [3], [27].

B. Cooperative Diversity MAC (CD-MAC)

To remedy the aforementioned problems, the following operation principles have been employed in the proposed CD-MAC:

- The RTS/CTS exchange is normally disabled.
- Each node (i) maintains $n_{i,j}$ for each possible neighbor, which is the number of consecutive communication failures. It is incremented when i 's transmission to j fails and is reset to zero when it is successful.
- On the other hand, the RTS/CTS exchange is used only when a sender (i) experiences transmission failures at least once with a particular neighbor (j) in the recent past. In other words, it is enabled when $n_{i,j}$ is larger than a certain threshold (n_{th}), which is called *RTS probing*, commonly used in multirate adaptation protocols [13], [25], [36]. Fig. 4(a) shows the four-way handshaking in the CD-MAC protocol.
- No cooperative communication is used for RTS and CTS control frames as in Fig. 4(a) because transmission failure of those short control frames are usually due to collisions. This should be contrasted with the simple scheme in Fig. 3(a), where the cooperative communication is applied to every frame including RTS and CTS.
- Cooperative communication is used for DATA and ACK frames when the data transmission failed but, subsequently, the RTS/CTS exchange was successful.
- Transmission of symbol blocks in CD-MAC is drawn in Fig. 4(b). Comparing to the transmission scenario shown in Fig. 3(b), time slot 1 for the symbol blocks of C-DATA (C-ACK) is skipped and thus, the frame transmission time is not larger than the original DATA (ACK). This is possible because the partner node (r_i) already overheard the original DATA frame from node i . Node i doesn't have to repeat the original symbol blocks unlike in Fig. 1 and Fig. 3(b). However, the first two symbol blocks can optionally be transmitted for the synchronization purpose between i and r_i . Regarding the ACK frame, r_j as well as j receives C-DATA and thus r_j can generate C-ACK as well.

As discussed above, CD-MAC does not transmit control frames in a cooperative manner. The cooperative transmission of RTS will make its communication more reliable, but it may simply extend the lifetime of a bad link, possibly impacting the routing performance by providing route information that contains a fragile link. Note that, in CD-MAC, the RTS/CTS exchange is used when data transmission fails at least once. Another RTS transmission failure (without cooperation) may be a good indication of a fragile link. If a link is unreliable and the problem persists for an extended period of time, it would be more appropriate to discover a new routing path consisting of robust links.

Fig. 5(a), 5(b) and 5(c) show the state transition diagram for the sender, the receiver and the partner, respectively. In Fig. 5(a), if

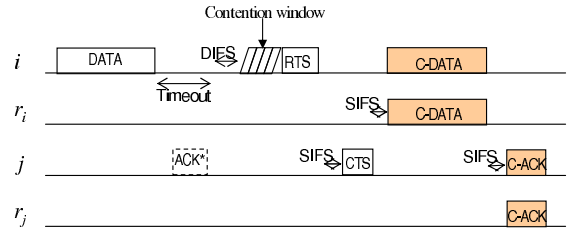

(a) Four-way handshaking

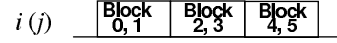

(b) Transmission blocks of C-DATA

Fig. 4. CD-MAC with partners r_i and r_j on a weak link (i, j). (RTS is normally not used in CD-MAC but it is employed in Fig. (a) because the preceding communication failed. The DATA frame in this figure consists of 6 blocks as in Fig. 3.)

n is smaller than n_{th} , the RTS/CTS exchange is skipped because the prior communication is successful and the communication environment is free from channel errors. No cooperative communication of DATA will be initiated. Otherwise, the RTS/CTS exchange will proceed the data communication and DATA is transmitted cooperatively with its partner. Fig. 5(b) draws the state transition diagram of a receiver. Fig. 5(c) corresponds to a partner of node i . Since node i can be either a sender or a receiver, the figure includes both state transitions. As a transmit partner (*i.e.*, node i is a sender), it will cooperatively send C-DATA when it hears RTS from i as well as CTS to i . Please refer to the left hand side of Fig. 5(c). As a receive partner (*i.e.*, node i is a receiver), it will cooperatively send C-ACK when it hears RTS to i , CTS from i and C-DATA from i . It is shown on the right hand side in Fig. 5(c).

C. Partner Selection and its Propagation

To employ the cooperative transmission in CD-MAC, every node proactively selects its partner by monitoring or overhearing its neighbors with respect to *link quality*. Note that no additional control packet is defined or used. If a node receives a frame, it measures and records the link quality between itself and the transmitter. The neighbor with the best link quality among all neighbors is chosen as its partner. There are three reasons behind this choice: (i) Communication between a node and its partner must be highly reliable. (ii) A partner with the best link quality is most probably the closest node. Therefore, cooperative communication in CD-MAC does not impair the spatial diversity because the spatial area reserved by the original sender (via carrier sensing) almost overlaps with that required for both the sender and the partner. (iii) It ensures that the sender and the partner share the same communication environment so that they can make a consistent decision on cooperation. According to [30], cooperative diversity can be effective when a node and its partner are spaced at least $\frac{\lambda}{4}$ apart, where λ is the wavelength. In the IEEE 802.11 standard using 2.4 GHz band, $\frac{\lambda}{4}$ is 3.125 cm (1.23 inches) and, thus, inter-node spacing is not a critical factor in achieving cooperative diversity in practical environments.

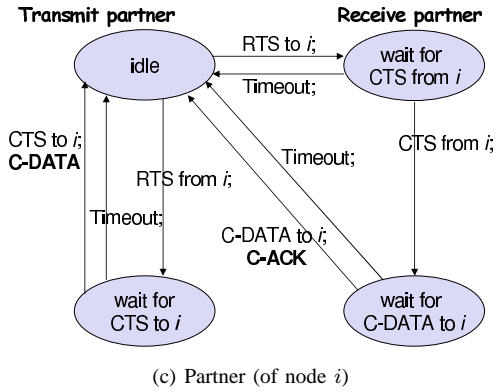
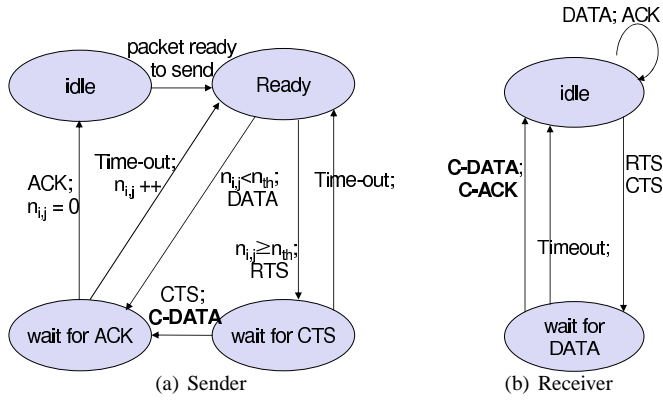

Fig. 5. State transition diagrams for a sender, a receiver and a partner. (Figure (c) shows the state transitions of a transmit partner as well as a receive partner.)

Note that metrics that can be used to indicate link quality are distance, load, interference level, *signal strength* (SS) and SINR. SINR is used in this study because it takes noise and interference into account and is measurable with no additional support [31]. It is also noted that other measures such as node mobility and remaining battery energy can be additionally used in selecting a partner; Low-mobility, high-energy node is preferred as a partner. Another important note is that the sender-partner binding is effective only for a pre-specified duration of time in a dynamic MANET. If a sender does not (over)hear any further frames from the chosen partner, the corresponding binding expires. Also, if a sender (over)hears a frame from a different node that exhibits a better link quality, it chooses this node as a new partner.

Once a partner is determined, each node must inform it to the chosen partner along with all the frames it transmits. For this purpose, it uses an address field (Addr4) in MAC frame format specified in IEEE 802.11 standard, which is not used in *ad hoc mode* of operation. Each node includes the identity of its partner in the Addr4 field of C-DATA as in Fig. 6 so that its neighbors as well as the selected partner become to know about the selection. CD-MAC does not require any data format changes in the original DCF, *i.e.*, C-DATA and C-ACK have the same data format as DATA and ACK, respectively. For instance, C-DATA frame format is exactly the same as DATA as in Fig. 6. A sender and a partner transmit the exactly same copy at the MAC layer while they are different at the physical layer as they encode the frame using DSTC. When the node does not have a frame to

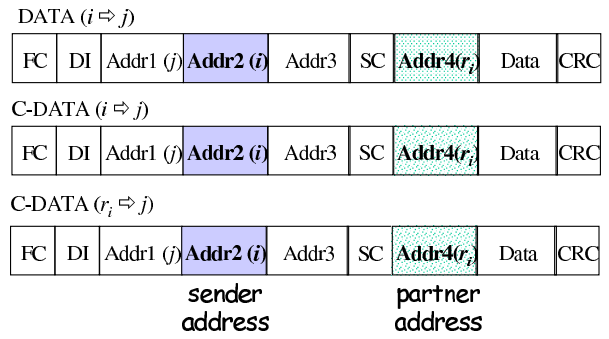

Fig. 6. Format of MPDU frames for DATA and C-DATA in the CD-MAC protocol (MPDU: MAC protocol data unit, FC: Frame control, DI: Duration/Connection ID, SC: Sequence control, Addr3: identity of basic service set or BSSID). (C-DATA from a node and its partner are exactly the same copy, where the sender address is in Addr2 and the partner address is in Addr4. However, at the physical layer, they become two different copies because of the DSTC encoding. MPDU frame for ACK and its cooperative version follows the same pattern.)

transmit for an extended period of time, it will broadcast a hello frame, the format of which follows C-DATA, with the destination (Addr1) and the source (Addr2) to be the transmitter itself. Note that the idea of hello packet is not new as it is extensively used in many popular network protocols such as AODV [19].

Three important questions in cooperative communication are: (i) What if the partner does not cooperate when it should? (ii) What if the partner cooperates when it shouldn't? And, (iii) what if two different senders happen to select the same partner? Consider the example in Fig. 2, where r_i and r_j are the partners of node i and j , respectively. When $n_{i,j} \geq n_{th}$ and the RTS/CTS exchange is successful, node i will send C-DATA. What if node r_i does not receive either the RTS or the CTS? It does not attempt to send C-DATA together with node i . However, this in fact does not do any harm in the sense that it still conforms to and does not violate the semantic of the 802.11 MAC protocol and there is no algorithmic ambiguity. Communication reliability is not enhanced in this case, though.

The second case happens when node i sends an RTS and node j replies with a CTS, which is successfully received by node r_i but not by node i . It may cause some confusion because node r_i transmits C-DATA but node i doesn't. However, it doesn't do any harm either in the existing DCF standard. Node i will receive an C-ACK for the frame which it doesn't send. Node i will ignore it and retransmit the same frame, which is a duplicate frame for node j . Such duplicate frames can be filtered out within node j 's MAC based on the original functionality of the DCF, called *duplicate packet filtering*. This algorithm matches the sender address (Addr2 in Fig. 6) and the sender-generated sequence control number (SC) of a new frame against those of previously-received ones. If there is a match, the receiver transmits ACK but ignores the duplicate frame.

The third case can be referred to as the partner conflict. When two senders (node i_1 and i_2) select the same partner (node r_i) and transmit concurrently, what should the partner do? Let us consider how it happens: Note again that cooperative communication is attempted only after the successful exchange of RTS/CTS in CD-MAC. Therefore, when both i_1 and i_2 wish to transmit data frames cooperatively, they already have exchanged RTS and CTS successfully with their corresponding receivers (say, j_1 and

j_2) concurrently. Considering the carrier sense mechanism, this means that node i_1 and j_1 are outside of the interference range of node i_2 and j_2 , and vice versa. However, it is hard to believe this occurs because node r_i is in proximity to both i_1 and i_2 . Even though it happens, node r_i will participate in the cooperative transmission of one of the two senders but will not be able to participate on behalf of the other sender. As for the latter, this is the case where the partner does not participate when it should. This does not make trouble as explained above.

IV. PERFORMANCE EVALUATION

In this section, the performance of the proposed CD-MAC protocol is evaluated in comparison to the conventional IEEE 802.11 DCF using ns-2 [23]. Section IV-A introduces the realistic reception model we have used in this study and Section IV-B explains the simulation parameters. Simulation results are presented in Section IV-C.

A. Signal Reception in the Modified Ns-2

The signal reception model implemented in ns-2 is based on three fixed PHY parameters, *i.e.*, *carrier sense threshold* (CSThresh), *receive threshold* (RxThresh) and *capture threshold* (CPThresh). They were introduced in Sections II-C and II-D. When a frame is received, each node compares the received signal power against CSThresh and RxThresh as outlined in Section II-C. If it is smaller than CSThresh, the receiver ignores the signal. If it is in between the two thresholds, the receiver considers the medium busy but does not receive the signal (frame in error). If it is higher than RxThresh, the receiver receives the frame. However, when the node receives another signal during receiving the first signal, their ratio is compared against CPThresh. If the ratio is larger than CPThresh, the stronger signal survives (if it is the first one) and the weaker signal is dropped; otherwise, both frames are considered failed.

This deterministic reception model based on the three thresholds serves reasonably well when evaluating high level protocols such as network and transport layer algorithms. However, when evaluating lower layer protocols, it is important to simulate a more realistic reception model. We modified ns-2 network simulator [23] to take *bit error rate* (BER) into consideration when determining the success or failure of a received signal. It is based on the following 3-step process: (i) Compute SINR, (ii) look up the BER-SINR curve to obtain BER, and (iii) calculate *frame error rate* (FER) and determine whether to receive or drop the frame.

First, SINR is calculated based on the equation introduced in Section II-C. According to the equation, the effective noise N is one of key parameters that determine SINR. In this paper, we first compute the thermal noise level within the channel bandwidth of 22 MHz in the IEEE 802.11 standard. According to the well known noise density of -174 dBm/Hz, it is -101 dBm. Assuming a system noise figure of 6 dB as in [22], the effective noise at the receiver is -95 dBm. It is assumed that the environment noise is fixed to be -83 or -90 dBm in this paper and that fading is contained in the noise.

Second, the BER-SINR curve used in our simulation study is shown in Fig. 7(a). It is obtained from the product specification of the Intersil HFA3861B radio chip [12], which models the QPSK modulation with 2 Mbps and reasonably matches with the

empirical curves in [8]. Note that the BER- E_b/N_0 curve given in [12] is converted to the BER-SINR curve based on the relationship $\text{SINR} = E_b/N_0 \times R/B_r$, where E_b is energy required per bit of information, N_0 is noise (plus interference) in 1 Hz of bandwidth, R is system data rate, and B_r is system bandwidth that is given by $B_r = R$ for QPSK in the Intersil chipset [32]. As observed in [16], [37] and shown in Fig. 7(a), cooperation reduces the required SNR by about 5 dB for the same BER. A frame consists of *physical layer convergence protocol* (PLCP) preamble, PLCP header and payload (data), and they may be transmitted at different rate with different modulation method. Hence, since BER is a function of SINR and modulation method as well as the cooperative diversity, it should be calculated separately for the three parts of a frame.

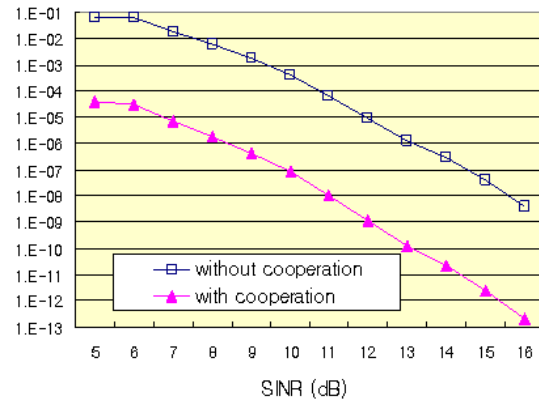

(a) BER versus SINR

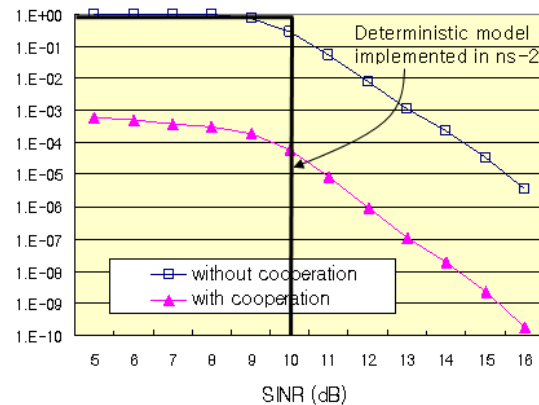

(b) FER versus SINR

Fig. 7. BER and FER comparison with and without cooperation for QPSK with 2 Mbps in the Intersil HFA3861B radio chip. (The PHY frame size for calculating FER is assumed to be 864 bits, *i.e.*, 144-bit preamble, 48-bit PLCP header and 84-byte payload.)

Third, once BER is obtained, FER can be calculated, which determines the percentage that a frame is received correctly. For example, given α -bit preamble, β -bit PLCP header and γ -bit payload with BER of p_a , p_b , p_c , respectively, FER is obtained by $1 - (1 - p_a)^\alpha (1 - p_b)^\beta (1 - p_c)^\gamma$. As shown in Fig. 7(b), FER without cooperation is much higher than that with cooperative diversity and that's how cooperative communication improves the reliability of a wireless link. For comparison, Fig. 7(b) also shows the FER curve used in unmodified ns-2. As discussed earlier in this section, if SINR is larger than CPThresh (the default value used in ns-2 is 10 dB as in Fig. 7(b)), the frame succeeds (FER = 0.0). Otherwise, it fails (FER = 1.0). In summary, FER is not

deterministically but probabilistically determined based on SINR in our simulation study, making our evaluation more realistic and meaningful.

B. Simulation Environment

It is assumed that 50 mobile nodes move over a square area of $300 \times 1500m^2$. Each simulation has been run for 900 seconds of simulation time. The propagation channel of *two-ray ground reflection model* is assumed with a data rate of 2 Mbps. The environment noise level of -83 or -90 dBm is modeled as a Gaussian random variable with the standard deviation of 1 dB. Noise level of -90 dBm is considered ignorable and interference from other transmitters dominates (see the SINR equation in Section II-C). On the other hand, noise level of -83 dBm is used to simulate a harsh communication environment.

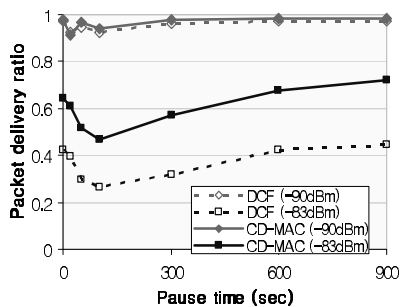

(a) Packet delivery ratio

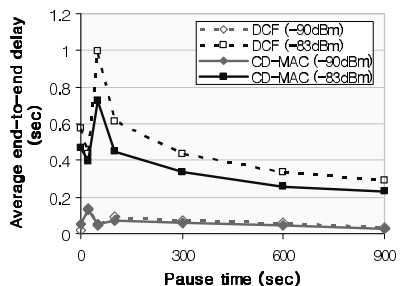

(b) Average end-to-end delay (sec)

Fig. 8. Performance comparison.

Four constant bit rate (CBR) sources transmit UDP-based traffic at 2 packets per second and the data payload of each packet is 512 bytes long. Source-destination pairs are randomly selected. Mobile nodes are assumed to move randomly according to the *random waypoint model* [34] with the node speed of 0~5 m/sec. Pause time between moves varies from 0 to 900 seconds. Note that the pause time of 0 second simulates a constant moving, high mobility scenario. And, the pause time of 900 seconds simulates a static scenario. *Ad-hoc On-demand Distance Vector* (AODV) [19] routing protocol is used to discover a routing path for a given source-destination pair.

Performance metrics are *packet delivery ratio*, *average end-to-end delay*, *route discovery frequency* and *cooperation ratio*. (i) The packet delivery ratio is the ratio of the number of data packets successfully delivered to the destination over the number of data packets sent by the source. (ii) The average

end-to-end delay is the averaged end-to-end data packet delay including all possible delays caused by buffering during route discovery, queuing delay at the interface, retransmission delays at MAC, propagation and transfer times. (iii) The route discovery frequency indirectly refers to the number of route failures because a source node is supposed to discover a new routing path if an existing one does not work. This happens when any one of the links of a multi-hop path breaks. Link breaks caused by node mobility are unavoidable but those due to unreliable communication environment can be overcome, which is in fact the main theme of this paper. (iv) Finally, the cooperation ratio refers to how often nodes cooperatively transmit frames in CD-MAC. Since CD-MAC attempts to use the original DCF whenever possible, it is interesting to know how often it succeeds and how often it resorts to cooperative communication.

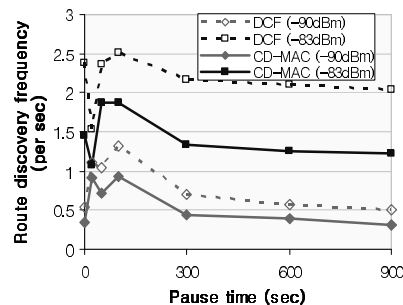

(a) Route discovery frequency (per sec)

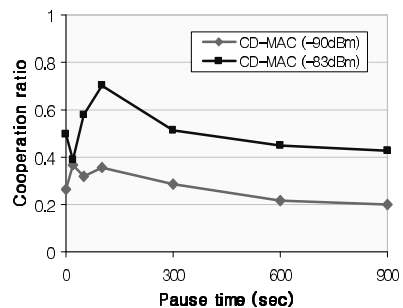

(b) Cooperation ratio

Fig. 9. Overhead and cooperation efficiency.

C. Simulation Results and Discussion

This subsection presents simulation results comparing DCF and CD-MAC. Fig. 8(a) shows the *packet delivery ratio* (PDR) of DCF and CD-MAC with two environment noise levels of -90 and -83 dBm. As shown in the figure, CD-MAC consistently outperforms DCF regardless the mobility but the gap becomes more significant (53~73% increases) when the environment noise is high (-83 dBm). This is because noisy environment makes wireless links less reliable and cooperative diversity is usefully exploited in CD-MAC in this case. It may be unexpected that performance goes down as pause time increases, particularly at pause time less than 100 seconds. However, the same trend has been consistently observed in other simulation-based studies including [38], [39]. This is due to the complex interplay among MAC and routing layer protocols in MANET environment.

Fig. 8(b) shows the corresponding average end-to-end delay with DCF and CD-MAC. In low-noise environment (-90 dBm), CD-MAC performs on par with DCF. However, except for very high mobility, CD-MAC decreases the average end-to-end delay by 25~37% for the relatively harsh environment (-83 dBm). CD-MAC makes the communication over unreliable (or less reliable) links possible and results in less retries, less route discoveries, less traffic, and less overhead decreasing the average end-to-end delay. In summary, CD-MAC significantly improves the network performance, particularly in a harsh environment (-83 dBm).

Less route discoveries in CD-MAC have been observed as shown in Fig. 9(a). In comparison to DCF, it is reduced by 22~50% and 35~69% with the noise level of -90 and -83 dBm, respectively. This clearly tells that the path or link reliability is improved significantly with CD-MAC. CD-MAC eliminates around half of the *false alarms* caused by link breaks due to collisions and thus helps reduce the control overhead for finding new routing paths.

Nodes in CD-MAC cooperate only when a primary link does not work. Fig. 9(b) shows how often nodes cooperate in CD-MAC. When the environment noise level is high (-83 dBm), the cooperation happens more frequently to survive the harsh communication environment. As the node mobility decreases (pause time increases), the cooperation ratio is decreased thanks to less unstable links. Note that the cooperation ratio is about 20% (or 40%) even with no mobility when the environment noise is -90 dBm (or -83 dBm). This is because there still exist a number of unreliable links in the network due to, for example, inter-node interference.

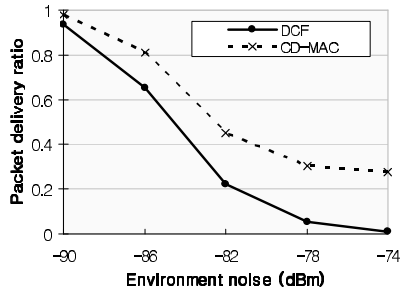
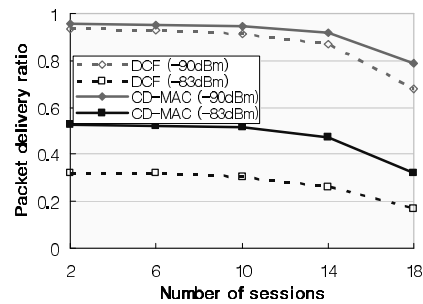

Fig. 10. Impact of environment noise.

To see the impact of environment noise in more detail, the packet delivery ratio with the different environment noise levels of -90~-74 dBm is shown in Fig. 10, where the pause time is fixed to 100 seconds during the simulation. While the performance decreases sharply in a noisier environment, CD-MAC consistently performs better than DCF and the gap is larger as the environment noise increases.

Network traffic is one of the most important system parameters. Fig. 11 shows the effect of network traffic in terms of the number of sessions and the packet rate. During the simulation, the pause time is fixed to 100 seconds and the two network traffic factors of 4 sessions and 2 packets per second are applied as default values. As can be expected, the performance is degraded with the increased network traffic. In particular, it quickly drops when the traffic increases beyond a certain threshold that is 14 sessions and 8 packets/sec in the simulation as shown in Fig. 11(a) and 11(b), respectively. This is because the network overhead is rapidly increased beyond the threshold and becomes congested. However,

CD-MAC still outperforms DCF and this effect is more significant in the harsh environment of -83 dBm.



(a) Varying the number of sessions

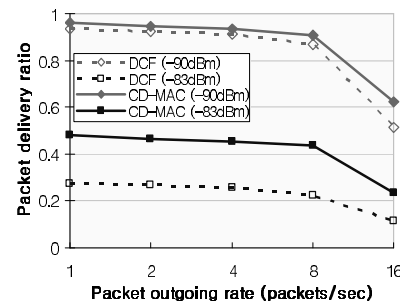

(b) Varying the packet rate

Fig. 11. Effect of network traffic on packet delivery ratio.

V. CONCLUSIONS AND FUTURE WORK

This paper proposes *cooperative diversity MAC* (CD-MAC) and discusses design issues and performance benefits in wireless ad hoc networks. When a communication link is unreliable, a sender transmits its signal together with its partner delivering the signal more reliably. In order to select a partner, each node monitors its neighbors with respect to link quality by receiving periodic hello packets and overhearing ongoing communications. The proposed CD-MAC is designed based on the IEEE 802.11 standards and does not require any changes in frame formats. For accurate performance study, we developed a realistic reception model based on BER and FER, which are derived from Intersil radio hardware specification. According to the system-level simulation results, CD-MAC significantly outperforms the conventional DCF of the original IEEE 802.11 standards, particularly in a harsh environment.

As a future work, exploiting cooperative diversity based on multi-channel interfaces will be investigated. It is also a promising future work to develop a cooperative diversity-aware routing algorithm. We expect this cross-layer approach can dramatically boost the network performance because it gives us a way to exploit other advantages of cooperative communication such as lengthening the transmission range in addition to improving the link reliability. More efficient partner selection is another important future work.

REFERENCES

- [1] S. Moh, C. Yu, S.-M. Park, H.-N. Kim, and J. Kim, "CD-MAC: Cooperative Diversity MAC for Robust Communication in Wireless Ad Hoc Networks," Proc. of IEEE ICC, June 2007.
- [2] R. Ramanathan, "Challenges: A Radically New Architecture for Next Generation Mobile Ad Hoc Networks," Proc. of ACM/IEEE Mobicom, pp. 132-139, 2005.
- [3] C. Yu, K. G. Shin, and L. Song, "Maximizing Communication Concurrency via Link-Layer Packet Salvaging in Mobile Ad Hoc Networks," IEEE Trans. on Mobile Computing, Vol. 6, No. 4, Apr. 2007.
- [4] Z. Lin, E. Erkip, and A. Stefanov, "Cooperative Regions and Partner Choice in Coded Cooperative Systems", IEEE Trans. on Communications, Vol. 54, Issue 7, pp. 1323-1334, July 2006.
- [5] J. N. Laneman, "Cooperative Diversity: Models, Algorithms, and Architectures," Cooperation in Wireless Networks: Principles and Applications, F. H. P. Fitzek and M. D. Katz (Eds.), Chapter 6, Springer, Netherlands, 2006.
- [6] A. Nosratinia, T. E. Hunter, and A. Hedayat, "Cooperative Communication in Wireless Networks," IEEE Communication Magazine, Vol. 42, No. 10, pp. 74-80, Oct. 2004.
- [7] J. N. Laneman and G. W. Wornell, "Distributed Space-Time Coded Protocols for Exploiting Cooperative Diversity in Wireless Networks," IEEE Trans. on Information Theory, Vol. 49, No. 10, pp. 2415-2425, Oct. 2003.
- [8] G. Scutari and S. Barbarossa, "Distributed Space-Time Coding for Regenerative Relay Networks," IEEE Trans. on Wireless Communications, Vol. 4, No. 5, pp. 2387-2399, Sep. 2005.
- [9] E. Kojima, T. Fujii, Y. Kamiya, and Y. Suzuki, "Distributed ARQ Using STBC for OFDM Ad-Hoc Networks," Proc. of 14th IST Mobile and Wireless Communications Summit, Jun. 2005.
- [10] A. Azgin, Y. Altunbasak, and G. AlRegib, "Cooperative MAC and Routing Protocols for Wireless Ad Hoc Networks," Proc. of IEEE GLOBECOM, 2005.
- [11] G. Jakllari, S. V. Krishnamurthy, M. Faloutsos, P. V. Krishnamurthy, and O. Ercertin, "A Framework for Distributed Spatio-Temporal Communications in Mobile Ad Hoc Networks," Proc. of IEEE INFOCOM, Apr. 2006.
- [12] Intersil HFA3861B chip Specification, Available from <http://www.chipdocs.com/pndecoder/datasheets/INTRS/HFA3861B.html>, 2006.
- [13] J. Kim, S. Kim, S. Choi, and D. Qiao, "CARA: Collision-Aware Rate Adaptation for IEEE 802.11 WLANs," Proc. of IEEE INFOCOM, 2006.
- [14] D. Gesbert, M. Shafi, D.-S. Shiu, P. J. Smith, and A. Naguib, "From Theory to Practice: An Overview of MIMO Space-Time Coded Wireless Systems," IEEE Journal on Selected Areas in Communications, Vol. 21, No. 3, pp. 281-302, Apr. 2003.
- [15] S. Alamouti, "Space Block Coding: A Simple Transmitter Diversity Technique for Wireless Communications." IEEE Journal on Selected Areas in Communications, Vol. 16, No. 10, pp. 1451-1458, Oct. 1998.
- [16] A. Scaglione, D. L. Goeckel, and J. N. Laneman, "Cooperative Communications in Mobile Ad-Hoc Networks: Rethinking the Link Abstraction," IEEE Signal Processing, Vol. 23, Issue 5, pp. 18-29, Sep. 2006.
- [17] N. Jindal, U. Mitra, and A. Goldsmith, "Capacity of Ad-Hoc Networks with Node Cooperation," Proc. of IEEE Int. Symp. on Information Theory, Dec. 2003.
- [18] M. Haenggi, "Analysis and Design of Diversity Schemes for Ad Hoc Wireless Networks," IEEE Journal on Selected Areas in Communications, Vol. 23, No. 1, pp. 19-27, Jan. 2005.
- [19] C. E. Perkins, and E. Royer, "Ad-hoc On-Demand Distance Vector Routing," IEEE Workshop on Mobile Computing Systems and Applications, 1999.
- [20] D. Johnson, and D. Maltz, "Dynamic Source Routing in Ad-Hoc Wireless Networks," Ch. 5, Mobile Computing, edited by T. Imielinski, and H. Korth. Kluwer Academic Publishers, pp. 153-181, 1996.
- [21] M. Zorzi and R. Rao, "Capture and Retransmission Control in Mobile Radio," IEEE Journal on Selected Areas in Communications, vol. 12, no. 8, pp. 1289-1298, 1994.
- [22] IEEE P802.11-94/132, Wireless Access Methods and Physical Layer Specifications: Elaborate Clear-Channel Assessment for Indoor Communication Systems Operating in Uncontrolled UHF & Microwave Bands, July 1994.
- [23] The Network Simulator ns-2, <http://www.isi.edu/nsnam/ns/>, 2006.
- [24] B. Bertsekas and R. Gallager, "Multiaccess Communication," Data Networks, chapter 4, second ed., Prentice Hall, 1992.
- [25] A. Kerman and L. Monteban, "WaveLAN-II: A High-Performance Wireless LAN for the Unlicensed Band," Bell Labs Technical J., pp. 118-133, Summer 1997.
- [26] L.E. Miller, "Carrier Sense Threshold/Range Control: Compilation of MANET Email Messages," <http://www.antd.nist.gov/wctg/manet/docs/carriersense.pdf>, Jan. 2004.
- [27] P. Muhlethaler and A. Najid, "Throughput Optimization in Multihop CSMA Mobile Adhoc Networks," Proc. European Wireless Conf., 2004.
- [28] Y. Fan and J. S. Thompson, "MIMO Configurations for Relay Channels: Theory and Practice," IEEE Trans. on Wireless Communications, Vol. 6, Issue 5, pp. 1774-1786, May 2007.
- [29] A. Bletsas, A. Khisti, D. P. Reed, and A. Lippman, "A Simple Cooperative Diversity Method Based on Network Path Selection," IEEE Journal on Selected Areas in Communications, Vol. 24, Issue 3, pp. 659-672, Mar. 2006.
- [30] A. Host-Madsen, "Capacity Bounds for Cooperative Diversity," IEEE Trans. on Information Theory, Vol. 52, No. 4, pp. 1522-1544, Apr. 2006.
- [31] S. Krcic and M. Dupcinov, "Improved Neighbor Detection Algorithm for AODV Routing Protocol," IEEE Communication Letters, Vol. 7, No. 12, pp. 584-586, Dec. 2003.
- [32] Intersil Prism WLAN Chipset Application Note: Tutorial on Basic Link Budget Analysis, Available from <http://www.sss-mag.com/pdf/an9804.pdf>, 2006.
- [33] J. N. Laneman, "Cooperative Diversity in Wireless Networks: Algorithms and Architectures," Ph.D. Thesis, Massachusetts Institute of Technology, Cambridge, MA, Aug. 2002.
- [34] J. Broch, D. A. Maltz, D. Johnson, Y.-C. Hu, and J. Jetcheva, "A Performance Comparison of Multi-Hop Wireless Ad Hoc Network Routing Protocols," Proc. of ACM/IEEE MobiCom, pp. 85-97, Oct. 1998.
- [35] A. Khandani, J. Aboundi, E. Modiano, and L. Zhang, "Cooperative Routing in Static Wireless Networks," IEEE Trans. Communications, Vol. 55, No. 11, Nov. 2007.
- [36] S. H. Y. Wong, H. Yang, S. Lu, and V. Bharghavan. "Robust rate adaptation for 802.11 wireless networks," Proc. of ACM/IEEE Mobicom, 2006.
- [37] A. Stamoulis and N. Al-Dhahir, "Impact of Space-Time Block Codes on 802.11 Network Throughput," IEEE Trans. on Wireless Communications, Vol. 2, Issue 5, pp. 1029-1039, Sep. 2003.
- [38] J. Broch, D. A. Maltz, D. B. Johnson, Y.-C. Hu and J. Jetcheva, "Performance Comparison of Multi-Hop Wireless Ad Hoc Network Routing Protocols," proc. of ACM/IEEE MobiCom, 1998.
- [39] C. Yu, S. Park, and H. Kim, "Every Node is Born Equal: Attacking Preferential Attachment in Peer-to-Peer Mobile Multihop Networks," Proc. of IEEE Percom Workshop on Mobile Peer-to-Peer Computing (MP2P'05), 2005.
- [40] P. Liu, Z. Tao, S. Narayanan, T. Korakis and S. Panwar, "CoopMAC: A Cooperative MAC protocol for Wireless LANs," IEEE Journal on Selected Areas in Communications, Special Issue on Cooperative Communications and Networking, Volume 25, No. 2, Feb. 2007.
- [41] Hao Zhu, and Guohong Cao, "rDCF: A Relay-Enabled Medium Access Control Protocol for Wireless Ad Hoc Networks," IEEE Trans. on Mobile Computing, Vol. 5, No. 9, Sep. 2006.